

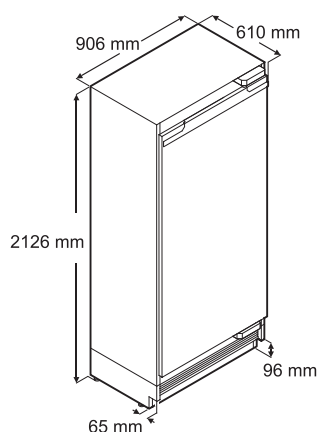

PROJECT		DETAILED SPECIFICATIONS	FULLY FROZEN FREEZER WITH NOFROST
LOCATION		ITEM CODE	EGN 9671 NOFROST
FINISH	STAINLESS STEEL	MANUFACTURE	LIEBHERR
		DATE	22/09/2023

Features



Power and Consumption

Energy class	A +
Power consumption in 24 hours	1,369 kWh / 24h
Power consumption per year	500 kWh / a
Climate class	SN-T
Noise - sound power	39 dB
Usable capacity, overall	529 l
Total Gross Capacity	653 l
Voltage	220-240 V ~
Frequency	50 Hz
Connection load	3.0 A 250 W

Dimension and Weight

Recess height	213 cm
Dimensions packed, Y / W / B	2.270,0 / 970.0 / 765.0 mm
Rectangular Dimensions H / W / D	213.36 - 213.4 / 91.4 / 63.5 cm
Weight (without packaging)	191.0 kg
Weight (packed)	214.0 kg

Control and Functions

Freezing temperature range	-14 ° C to -27 ° C
Control system	3.5 "Color Touch Screen, Touch and Swipe
Handling	Electronic touch screen
Temperature display	Freezing
Fault: warning sound	Audiovisual
Frost door warning sound signal	Sound
SuperFrost	Setting according to quantity
Closing closure	SoftSystem
SmartDeviceBox	Pre-installed

Freezing

Characteristic stars	4
Cooling technology	NoFrost
Duration of storage in damage	25 h
Freezing capacity within 24 hours	10 kg
Drawers	3
Material of the shelves of the freezer	Glass
Illumination	Enlightened sidewalls
FrostSafe system	With closed drawers with a transparent front

Installation

Door fittings	Door on the door
Door opening	Left convertible
Angle of door opening	115 °
Ventilation	Base ventilation

CONTACT :
MOBILE :
E-MAIL :

MVP APPLIANCES

No. 1,11 B Street, Al Quoz Industrial Area 4, Dubai - UAE
Tel : +971 4 380 9490 | Fax : +971 4 346 5614
WEBSITE: www.mvpappliances.com