





## Exposed part for concealed S.L.bath-shower valve **CHERIE**

MODEL **CH002100**

Exposed part for concealed S.L.bath-shower valve, 2 outlet automatic diverter, without concealed part, for item ZA004210 - ZA004213



### AVAILABLE FINISHINGS

- 
**6T** 6T Chrome/Matt Black
- 
**7C** 7C Gold/Matt Black
- 
**7D** 7D Polished Nickel/Matt Black
- 
**7E** 7E Rose Gold/Matt Black

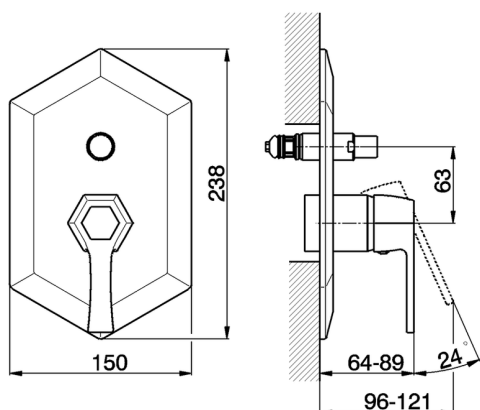

### CHARACTERISTICS

Installation **Concealed**  
 Required concealed parts **ZA004213**  
**ZA004210**



## Concealed single lever bath-shower mixer CONCEALED

MODEL **ZA004210**

Concealed single lever bath-shower mixer, automatic diverter, with noise reducers, without trim kit



AVAILABLE FINISHINGS

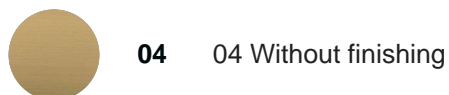

CHARACTERISTICS

Concealed **1**  
 Cartridge Spare Parts **ZZ93196000**  
**38 mm Cartridge**

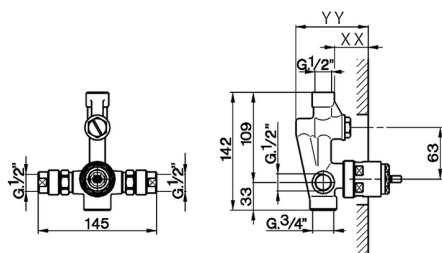

Piastra/Plate/Plaque/Platte/Placa

2-3mm: XX 25-55 YY 72-102

10mm: XX 15-40 YY 62-87



2023-11-24